

入力轴
Input shaft

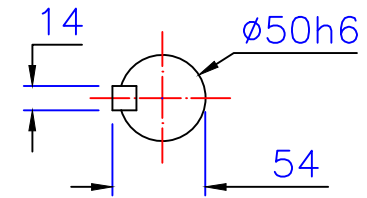

出力轴
Output shaft

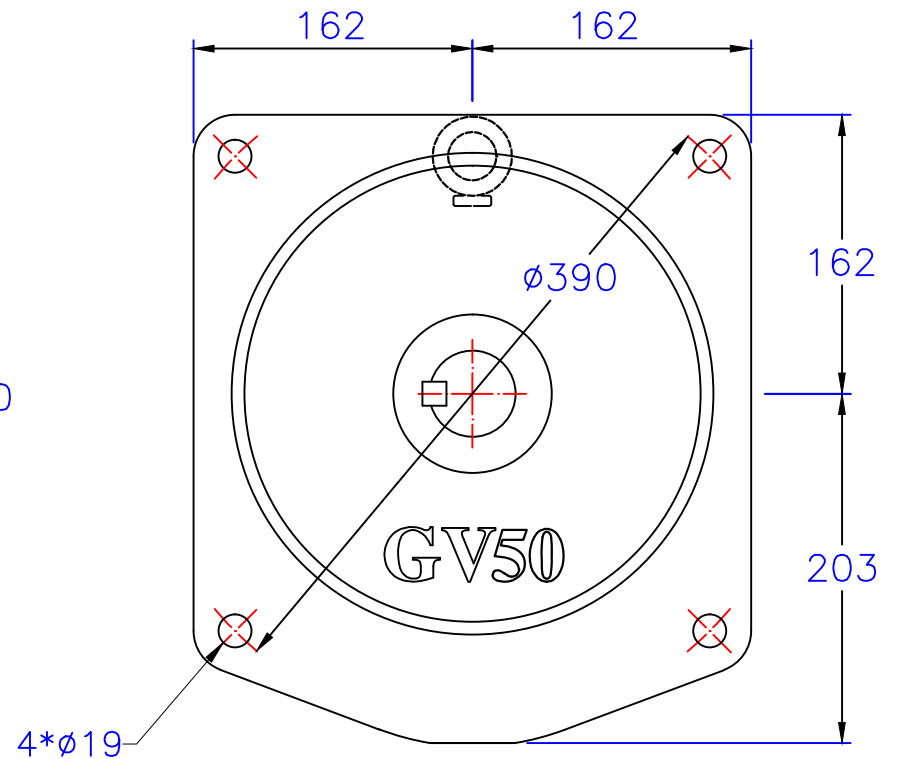
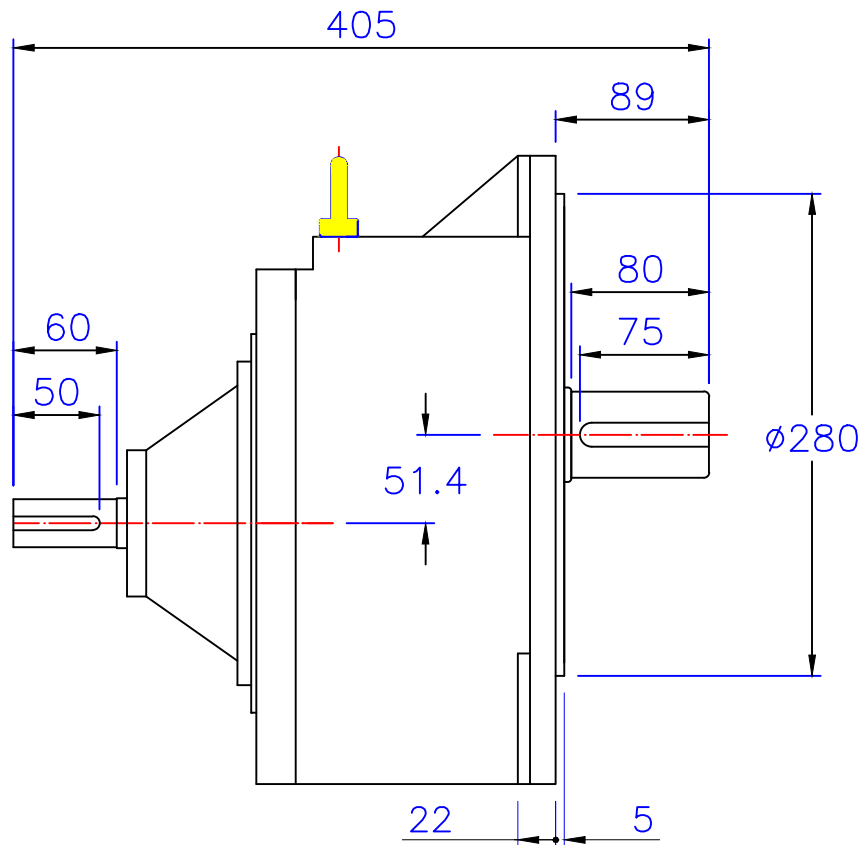

版权
所有

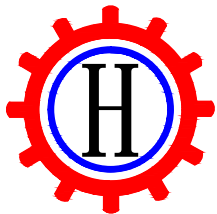

東莞豪鑫機電有限公司
DONG GUAN HOU SIN CO.,LTD.
Tel:86-769-81568855
Fax:86-769-81568858
Http://www.housinmotor.com

3HP立式双轴型齒輪減速机

圖號	GVD50-2200-70~120	繪圖	肖飞平
版本	第三版	審核	
修訂日期	2015-5-9	比例	1:1